

19" True Flat Projected capacitive Multi-Touch Monitor

Products application :

- POS Terminal
- Industrial PC
- Kiosk
- Gaming
- Medical apparatus
- Personal computer
- Mobile GPS
- Office automation
- Security system of the house
- Car-mounted amusement
- Military equipment
- Communicate



AIM-TMPCT190-R15



AIM-TMOPPCT190-R15

Order information :

Touch interface :

Mount type :

AIM-TMPCT190-R15	USB (Multi-Touch*10)	VESA (Without Stand)
AIM-TMPCT190-R16	RS232 (Single-Touch)	
AIM-TMOPPCT190-R15	USB (Multi-Touch*10)	Embedded (Open Frame)
AIM-TMOPPCT190-R16	RS232 (Single-Touch)	

AIM-TMPCT190-R15 V	USB (Multi-Touch*10)	POS Stand (1.1kg)
AIM-TMPCT190-R16 V	RS232 (Single-Touch)	

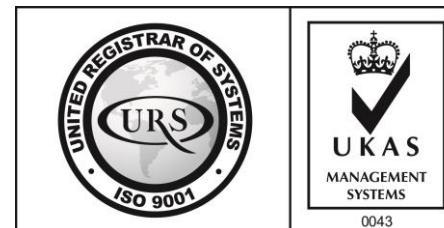

19" True Flat Projected capacitive Multi-Touch Monitor

Display Specifications :

Active Area	376 × 301 mm
Pixel Pitch	0.294 × 0.294 mm
Brightness	250 cd/m ²
Contrast Ratio	1000 : 1
Resolution	1280 x 1024 (SXGA)
Viewing Angle	L/R178° ; U/D170°
Response Time	5ms (Tr + Tf)
Display Colors	16.7M
Display Modes	640×480 ; 800×600 ; 1024×768 ; 1280×1024
Signal input	VGA ; Audio ; DVI
Speaker	1W (8Ω) × 2
OSD Keyboard	⊙Power ⊙Auto adjust ⊕ ⊖ ⊙Menu
Power Source	DC 12V (DC Jack Φ2.1mm)
Power Consumption	≤16w
Storage 、 Operation	-20~60°C ; 0~50°C
VESA	75×75 ; 100×100 mm
Casing Colors	Black (OEM other colors)
Casing Size 、 Weight	413.7 × 338.5 × 46 mm ; 5.7 kg (W×H×D) (Without Stand)
Carton 、 gross weight	490 × 500 × 155 mm ; 6.2 kg (W×H×D)
Accessory	VGA cable / Audio cable / AC90~260V Adapter / Power cable / USB or RS232 cable / Cleaning wipes / Driver Disk ※DVI cable (Optional)

※AiM Touch has the right to update specs without further notice.



AIM-TMOPPCT190-R15



19" True Flat Projected capacitive Multi-Touch Monitor

Touch Feature :

Input Method	Capacitive stylus, Finger
Linearity	≤2.5mm
Surface	≥7H
Life Time	Unlimited
Application	Writing and Signature Capture Capability

Software Feature :

Draw Test	Position and linearity verification
Controller	Support multiple controller
Languages	English · Simple Chinese · Traditional Chinese · Japanese · French · German · Spanish · Korean · Arabic · Czech · Danish · Dutch · Greek · Hungarian · Italian · Norwegian · Russian · Polish · Portuguese · Slovenian · Swedish · Thai · Turkish
Mouse Emulator	Right / left button emulation. Auto Right / left Click (PDA function)
Touch Style	Drawing a Mode · button a Mode · Touch Off/ on Switch
Double Click	Configurable double click speed · Configurable double click area
Sound Modes	No sound · Touch down · Touch up
Display Support	display rotation · Support multiple monitors
Division Pattern	Support two halves and four parts with touch function, you can also create your own division patterns.
Settings:	
Edge compensation	Support edge compensation and you can also add your own numbers for it.
Support O.S	All Windows-32/64bit O.S Android ; Linux ; MAC



AIM-TMPCT190-R15 V



3 Year Warranty
LCD Panel 1 Year

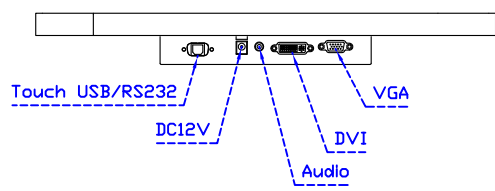
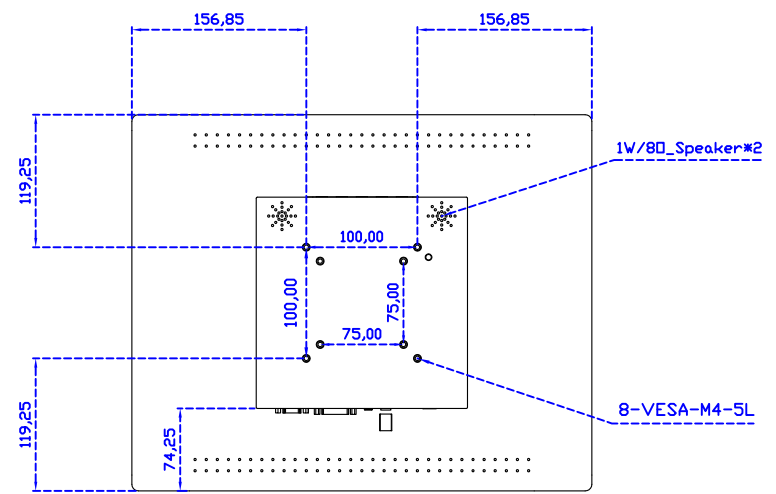
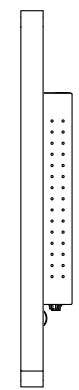
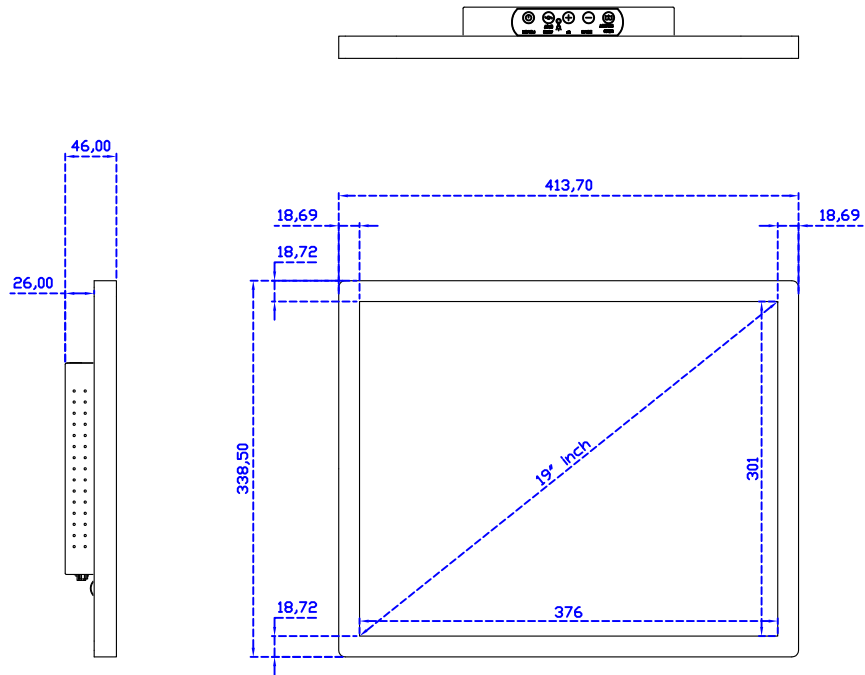

19" Touch Monitor.
(VESA Mount)

AIM-TMPCT190-R15

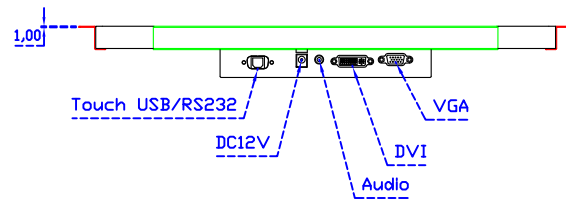
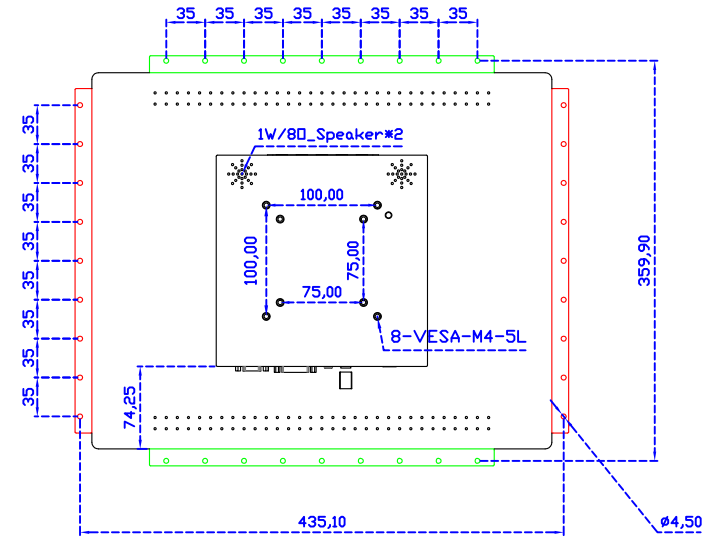
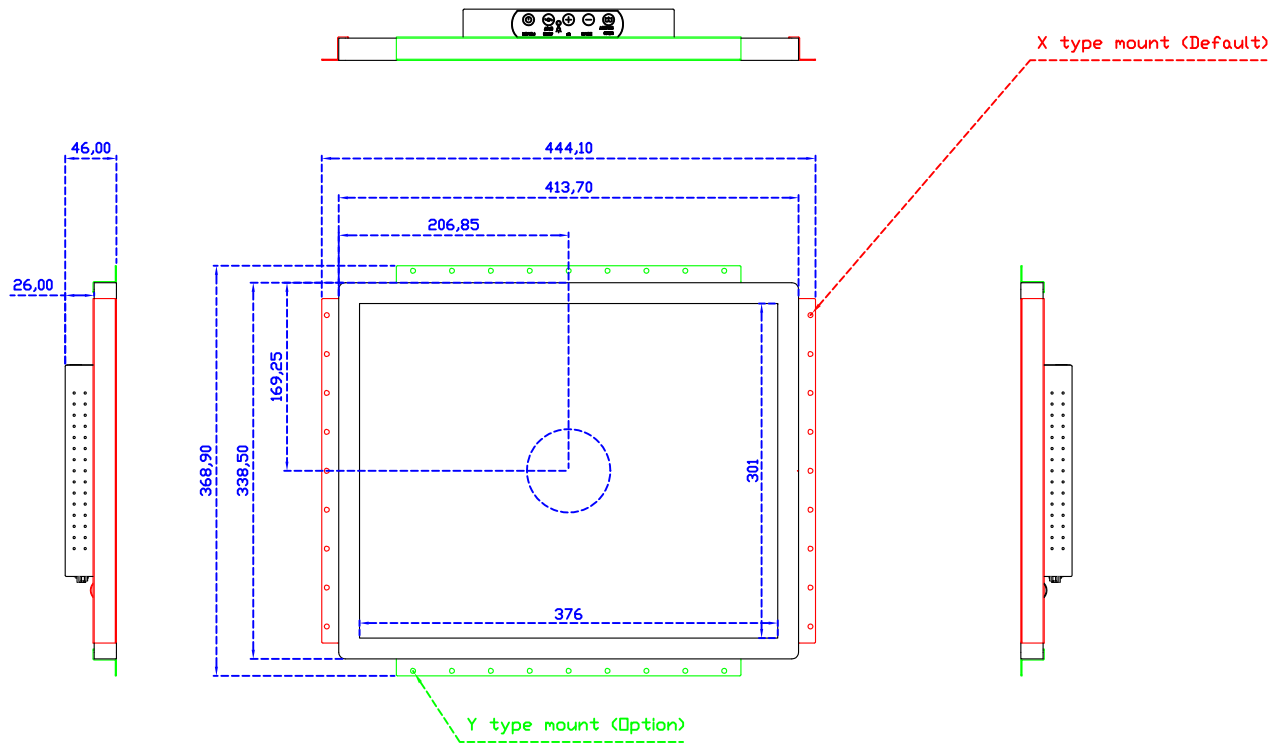

19" Embedded Touch Monitor.
(Open Frame)

AIM-TM0PPCT190-R15

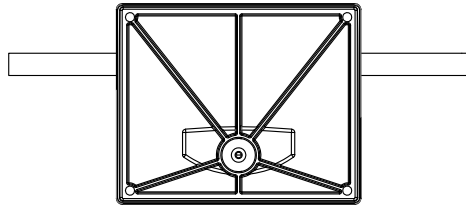
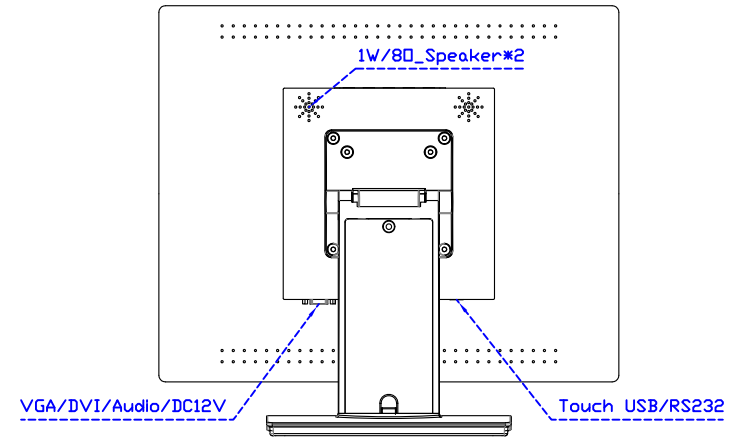
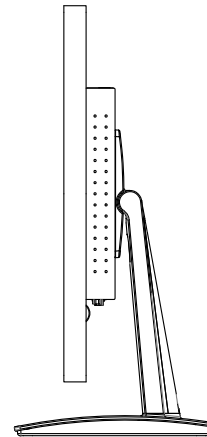
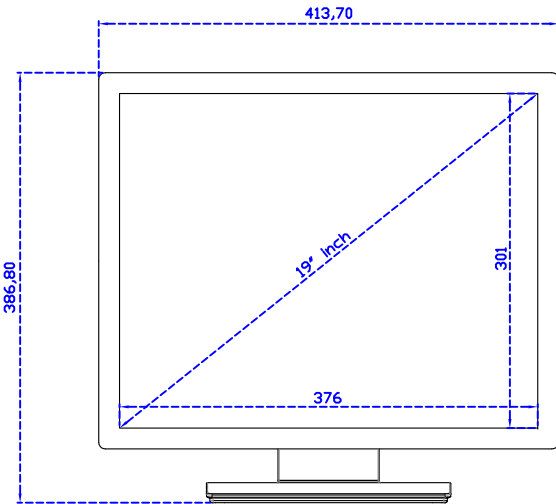
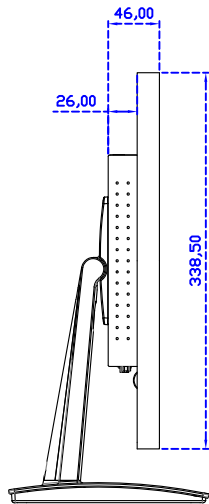
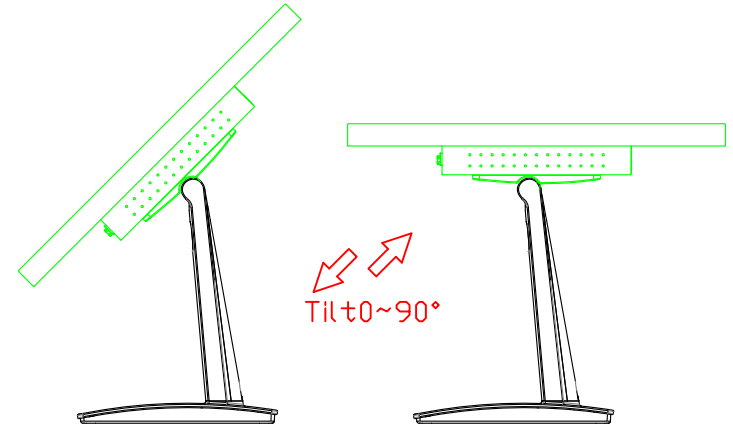
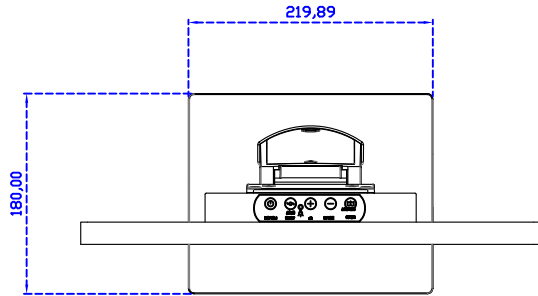

19" Desktop Touch Monitor.
(POS Stand)

AIM-TMPCT190-R15V