

# 17" True Flat Projected capacitive Multi-Touch Monitor



## Products application :

- POS Terminal
- Industrial PC
- Kiosk
- Gaming
- Medical apparatus
- Personal computer
- Mobile GPS
- Office automation
- Security system of the house
- Car-mounted amusement
- Military equipment
- Communicate



AIM-TMPCT170-R25



AIM-TMOPPCT170-R25

## Order information :

### Touch interface :

### Mount type :

AIM-TMPCT170-R25	USB ( Multi-Touch*10 )	VESA ( Without Stand )
AIM-TMPCT170-R26	RS232 ( Single-Touch )	
AIM-TMOPPCT170-R25	USB ( Multi-Touch*10 )	Embedded ( Open Frame )
AIM-TMOPPCT170-R26	RS232 ( Single-Touch )	

AIM-TMPCT170-R25 V	USB ( Multi-Touch*10 )	POS Stand ( 1.1kg )
AIM-TMPCT170-R26 V	RS232 ( Single-Touch )	

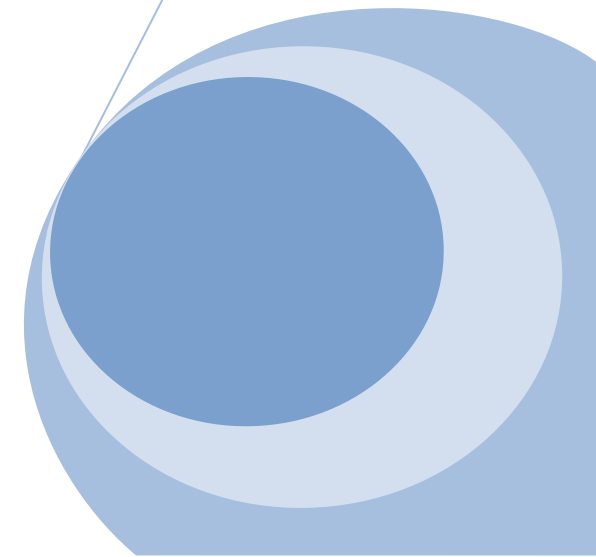
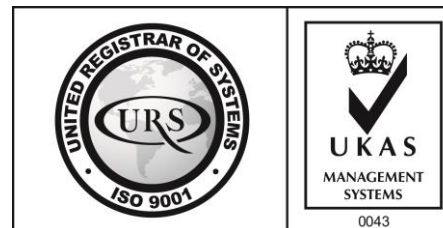

## 17" True Flat Projected capacitive Multi-Touch Monitor

### Display Specifications :

Active Area	337 × 270 mm
Pixel Pitch	0.264 × 0.264 mm
Brightness	250 cd/m <sup>2</sup>
Contrast Ratio	1000 : 1
Resolution	1280 x 1024 ( SXGA )
Viewing Angle	L/R176° ; U/D170°
Response Time	5ms ( Tr + Tf )
Display Colors	16.7M
Display Modes	640×480 ; 800×600 ; 1024×768 ; 1280×1024
Signal input	VGA ; Audio ; Display Port ; HDMI
Speaker	1W ( 8Ω ) × 2
OSD Keyboard	⊙Power ⊙Auto adjust ⊕ ⊖ ⊙Menu
Power Source	DC 12V ( DC Jack Φ2.1mm )
Power Consumption	≤15w
Storage 、 Operation	-20~60°C ; 0~50°C
VESA	75×75 ; 100×100 mm
Casing Colors	Black ( OEM other colors )
Casing Size 、 Weight	375.4 × 307.8 × 46 mm ; 3.8 kg ( W×H×D ) ( Without Stand )
Carton 、 gross weight	440 × 455 × 155 mm ; 5.3 kg ( W×H×D )
Accessory	VGA cable / HDMI cable / Audio cable / AC90~260V Adapter / Power cable / USB or RS232 cable / Cleaning wipes / Driver Disk ※DP cable ( Optional )



AIM-TMOPPCT170-R25



※AiM Touch has the right to update specs without further notice.



## 17" True Flat Projected capacitive Multi-Touch Monitor

### Touch Feature :

Input Method	Capacitive stylus, Finger
Linearity	≤2.5mm
Surface	≥7H
Life Time	Unlimited
Application	Writing and Signature Capture Capability

### Software Feature :

Draw Test	Position and linearity verification
Controller	Support multiple controller
Languages	English · Simple Chinese · Traditional Chinese · Japanese · French · German · Spanish · Korean · Arabic · Czech · Danish · Dutch · Greek · Hungarian · Italian · Norwegian · Russian · Polish · Portuguese · Slovenian · Swedish · Thai · Turkish
Mouse Emulator	Right / left button emulation. Auto Right / left Click ( PDA function )
Touch Style	Drawing a Mode · button a Mode · Touch Off/ on Switch
Double Click	Configurable double click speed · Configurable double click area
Sound Modes	No sound · Touch down · Touch up
Display Support	display rotation · Support multiple monitors
Division Pattern	Support two halves and four parts with touch function, you can also create your own division patterns.
Settings:	
Edge compensation	Support edge compensation and you can also add your own numbers for it.
Support O.S	All Windows-32/64bit O.S Android ; Linux ; MAC



AIM-TMPCT170-R25 V



**3 Year Warranty**  
LCD Panel 1 Year

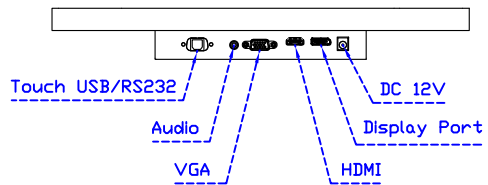
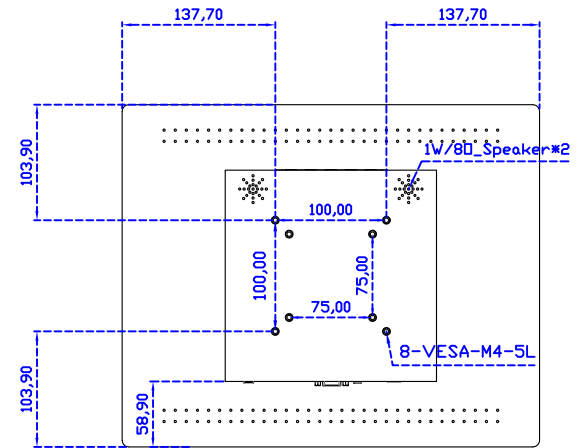
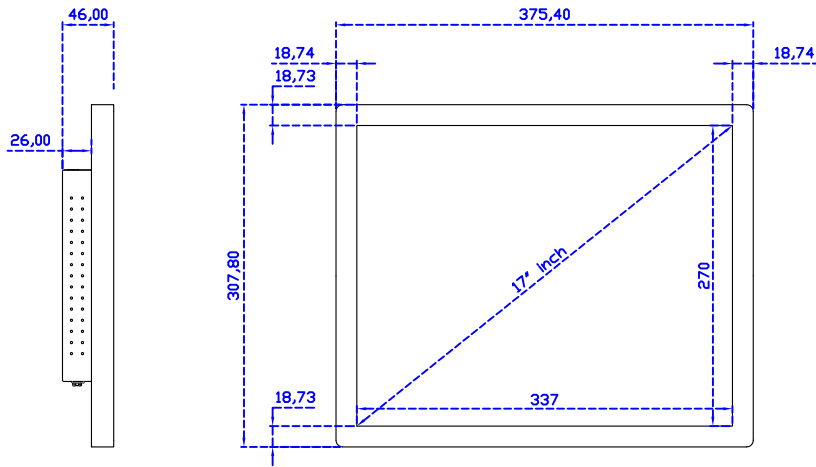

17" Touch Monitor.  
(VESA Mount)

AIM-TMPCT170-R25

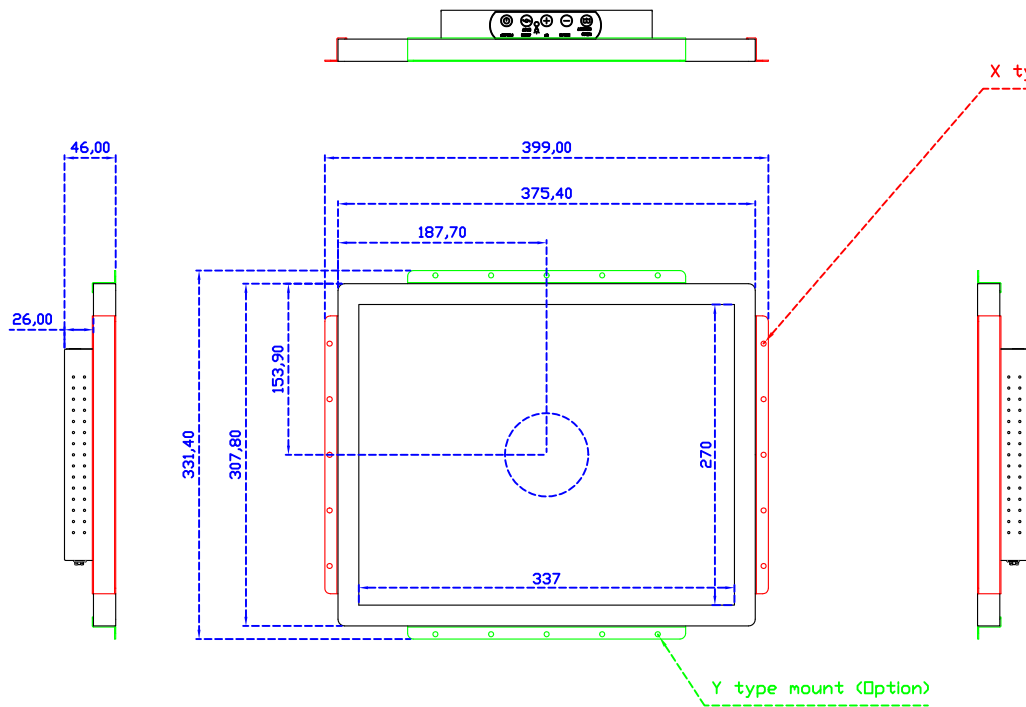

X type mount (Default)

Y type mount (Option)

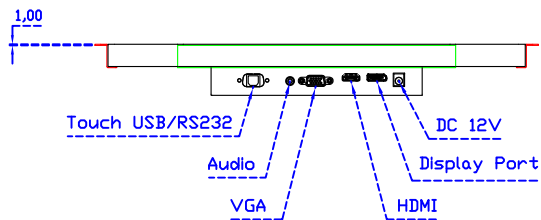
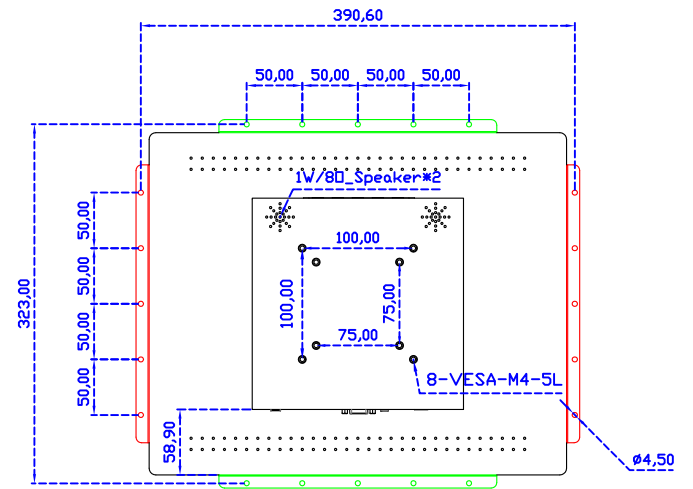

17" Embedded Touch Monitor.  
(Open Frame)

AIM-TM0PPCT170-R25

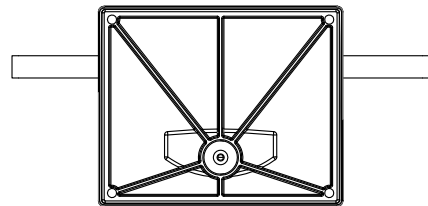
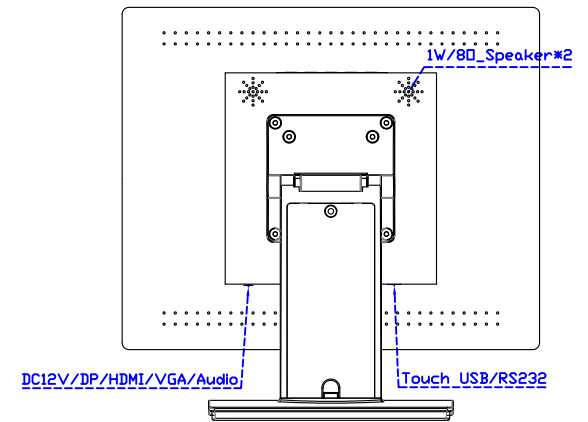
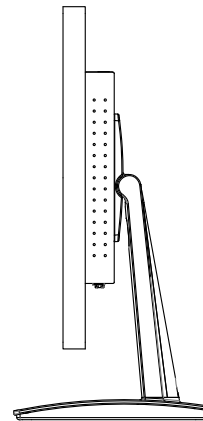
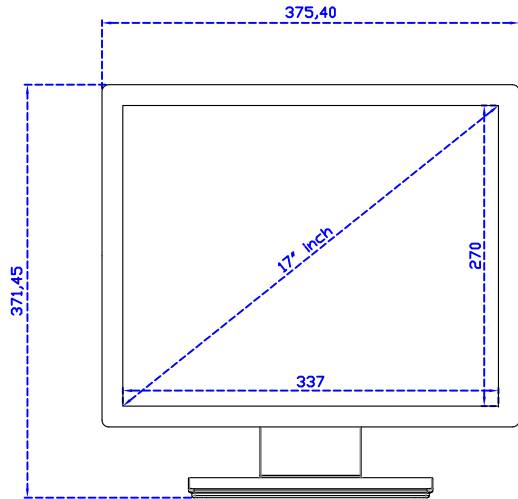
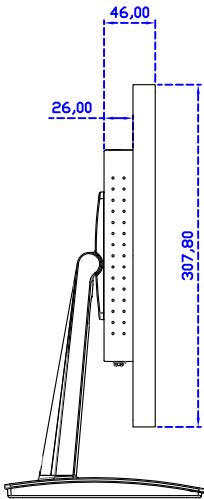
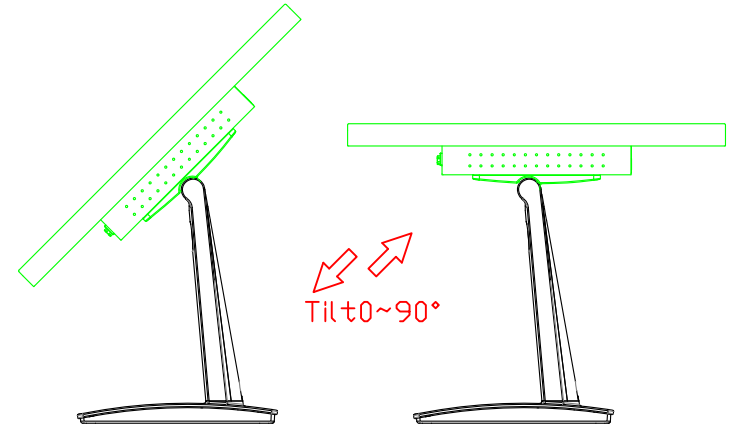
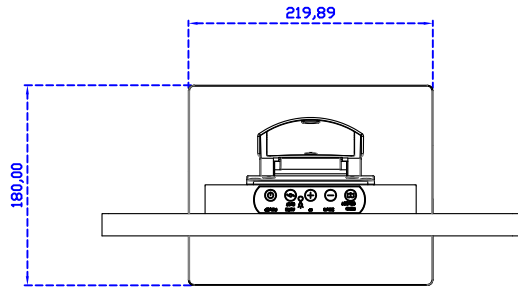

17" Desktop Touch Monitor.  
(POS Stand)

AIM-TMPCT170-R25 V