

17" inch Touch Monitor (Infrared Ray Multi-Touch)

Products application :

- POS Terminal
- Industrial PC
- Kiosk
- Gaming
- Medical apparatus
- Personal computer
- Mobile GPS
- Office automation
- Security system of the house
- Car-mounted amusement
- Military equipment
- Communicate

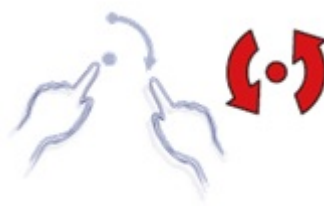
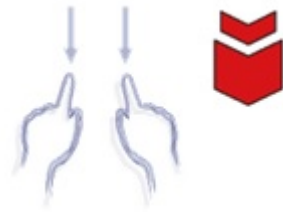

17" inch Touch Monitor (Infrared Ray Multi-Touch)

Display Specifications :

Active Area	337 × 270 mm
Pixel Pitch	0.264 × 0.264 mm
Brightness	250 cd/m ²
Contrast Ratio	1000 : 1
Resolution	1280 × 1024 (SXGA)
Viewing Angle	L/R 176° ; U/D170°
Response Time	5 ms (Tr + Tf)
Display Colors	16.7M
Display Modes	640×480 ; 800×600 ; 1024×768 ; 1280×1024
Signal input	VGA ; Audio ; DVI
Mini-Audio out	1W (8Ω) × 2
OSD Keyboard	⊙ Menu/Select ⊙ - ⊙ + ⊙ Auto/Exit ⊙ Power
Power Source	DC 12V ; ≤15w ; Standby ≤1w
Power Consumption	
Storage · Operation	-20~60°C ; 0~50°C
VESA	75×75 or 100×100 mm
Casing Colors	Black
Casing Size · Weight	381 × 313 × 52 mm ; 5.3kg (W×H×D)
Carton · gross weight	550 × 400 × 180 mm ; 6.8kg (W×H×D)



Touch Feature :

Input Method	It detects anything that blocks lights
Linearity	≤2.5mm
Surface	≥7H
Life Time	Unlimited
Application	Writing and Signature Capture Capability
PC Link	USB or RS232(Single-Touch)

Software Feature :

Calibration	4 points or 16 points or 25 points
Draw Test	Position and linearity verification
Controller	Support multiple controllers
Languages	English · Simple Chinese · Traditional Chinese · Japanese · German
Mouse Emulator	Right / left button emulation. Auto Right / left Click (PDA function)
Touch Style	Drawing a Mode · button a Mode · Hide cursor
Double Click	Configurable double click speed · Configurable double click area
Sound Modes	No sound · Touch down · Touch up
Display Support	display rotation · Support multiple monitors
Division Pattern Settings:	Support two halves and four parts with touch function, you can also create your own division patterns.
Edge compensation	Support edge compensation and you can also add your own numbers for it.
Support O.S	All Windows-32 bit O.S Windows7-8-10 ; XP-64 bit O.S Android ; A II Linux ; MAC



Order Information :

AIM-TMIR170-R01A :
Accessory

【VGA/DVI/AUDIO/USB-TOUCH】
VGA Cable/Audio Cable/Power Cable/AC90~260V Adapter/USB or RS232 Cable/Cleaning wipes/Driver Disk
※DVI Cable(Optional)

AIM-TMIR170-R02A : 【VGA/DVI/AUDIO/RS232-TOUCH】



3 Year Warranty
LCD Panel 1 Year



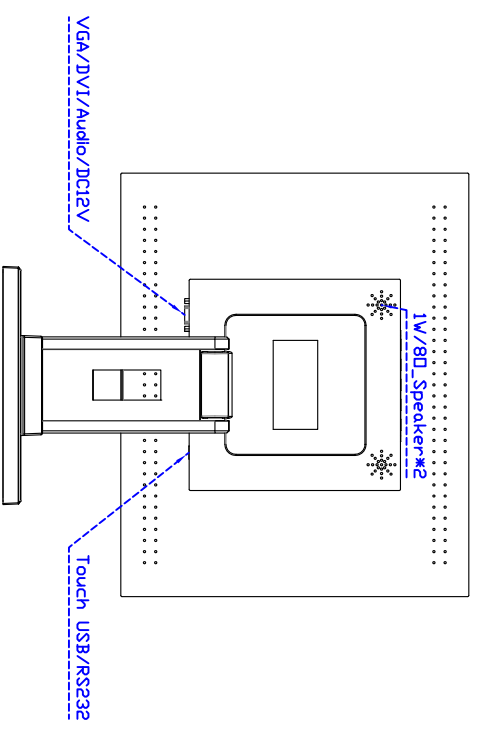
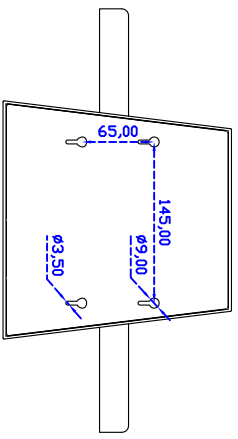
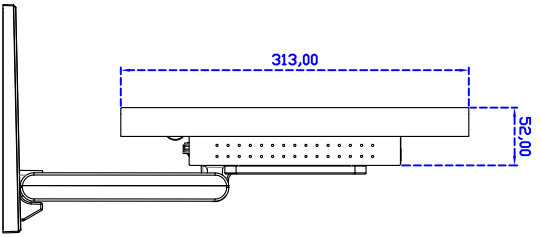
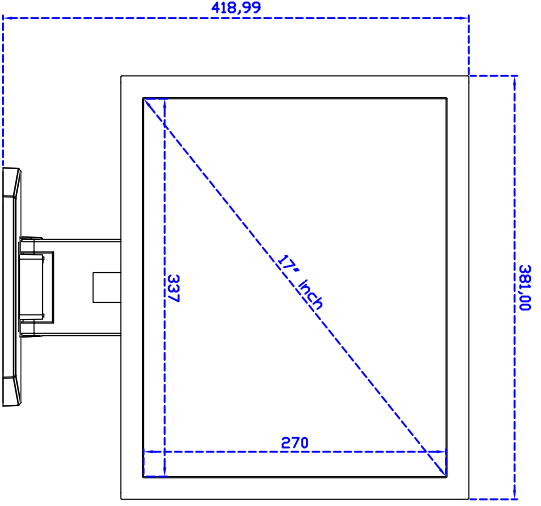
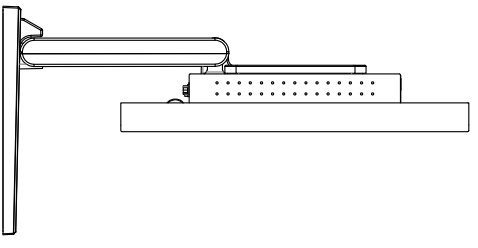
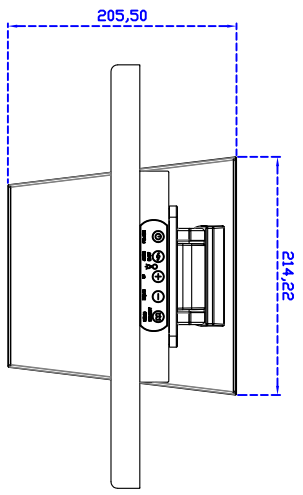

17" Desktop Touch Monitor.

AIM-TMIR170-R01A